

ZERO 100

Midrange specifications:

Name		HG-100Z
DC resistance	Rdc	2,5 Ω
Nominal impedance	ZN	3 Ω
Resonance frequency	fs	106,0 HZ
Voice coil diameter		25 mm
Mechanical Q factor	Qms	3,14
Electrical Q factor	Qes	0,78
Total Q factor	Qts	0,63
Moving mass Mms		5,83 g
Effective piston area	Sd	79 cm²
Mechanical resistance	Rms	1,24 Kg/s
Compliance	Cms	0,39 mm/N
Force factor	BL	3,45 Tm
Equivalent air volume	Vas	3,39 dm³
Efficiency	η	0,50 %
SPL 2,83V/1m		94,2 dB

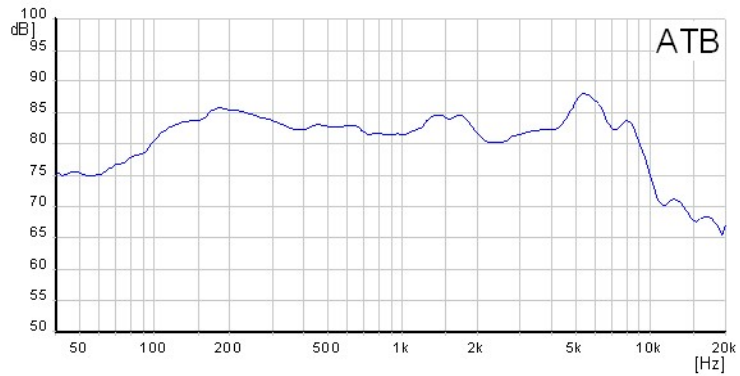

Cone: **Paper**
 Spider: **Nomex**
 Surround: **Rubber**
 Coil former: **Aluminum**
 Basket: **Steel**
 Dust cap: **Silk**

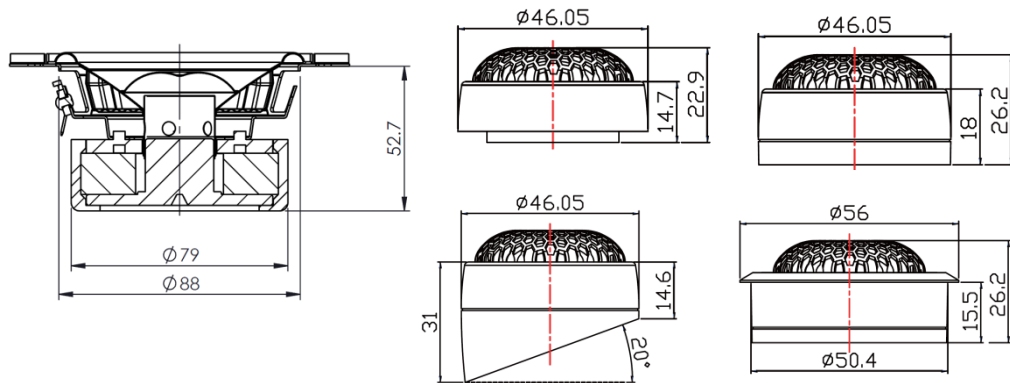

Tweeter specifications:

Name		HG-25SG
DC resistance	Rdc	3,3 Ω
Nominal impedance	ZN	4 Ω
Resonance frequency	fs	1580 HZ
Voice coil diameter		25 mm

